

How to Build a Waterwheel

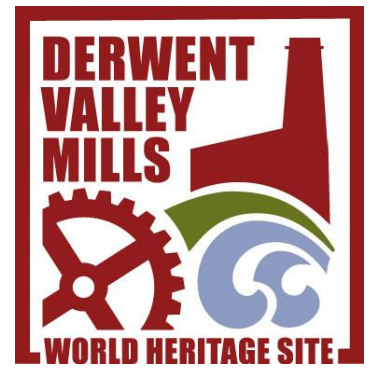

How this links with the Derwent Valley Mills World Heritage Site:

All the mill buildings along the Derwent Valley Mills World Heritage Site were built to be powered by the force of water. Water from rivers and streams were channelled towards the mills and used to turn huge waterwheels. The wheels were attached to metal shafts and pulley systems and as the wheels turned they were able to power many machines through the whole mill. They were huge and were positioned inside or outside the mill.

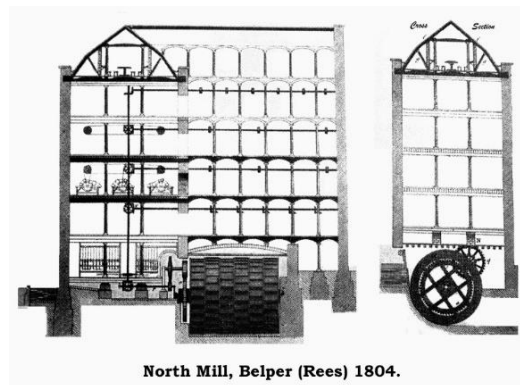

Cromford Mill

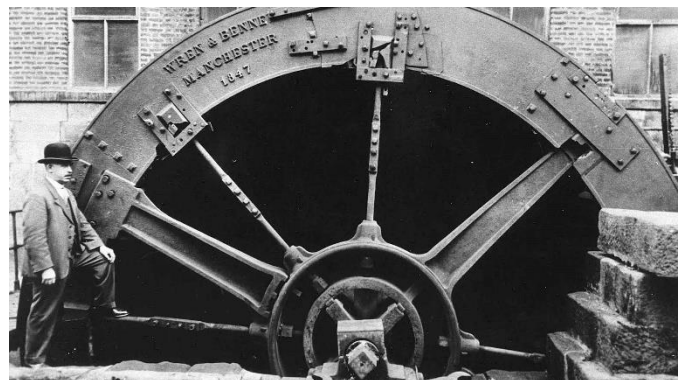

Masson Mill

Milford Mill

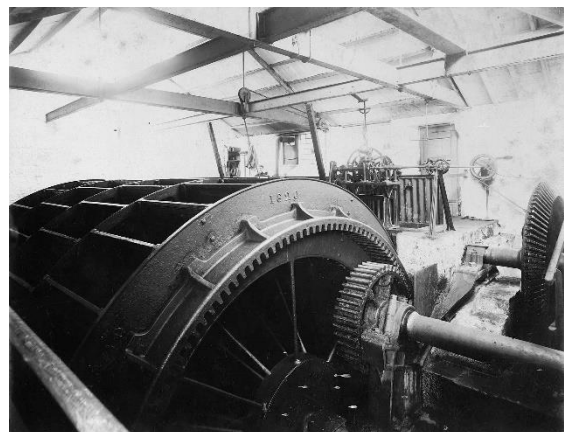

Photos courtesy of Adrian Farmer

You will need:

To make the simple waterwheel pictured above you will need the following items or if you are inspired by alternative design ideas at the end of this activity you will need some additional materials.

- Plastacine or Blue Tac
- Pencil
- Medium or large milk bottle
- Yoghurt pot
- Piece of thread
- 3 Craft sticks cut in half
- Cellotape
- Scissors



How to have a go:

Step 1:

- Mold a piece of Plastacine or Blue Tac into a circular disc about 1 cm thick
- Push a sharpened pencil half way through the Plastacine



Step 2:

- Cut 4 craft sticks in half



Step 3:

- Push the cut edge of a craft stick into the Plastacine until it touches the pencil and it is firm
- Position the first 4 sticks in a cross shape around the pencil
- The next 4 sticks fill the gaps between the cross sticks
- Make sure they are all nice and firm



Step 4:

- Take a clean yogurt pot (any shape will do, but if it is small you may need more than 1)
- Draw 8 'paddle shapes' with felt pen
- Cut the paddle shapes out with scissors



Step 5:

- Use Cellotape to attach a paddle shape to each craft stick
- Try to make sure they are all facing the same way, with the straight edge furthest from the craft stick

**Step 7:**

- Use scissors to cut the top half of the milk bottle off
- Then cut a little groove on each side, try to make them in line and the same size
- This will be where the pencil (axle) sits

**Step 8:**

- To make room for the wheel to fit you will need to cut out some plastic from the front and back of the bottle
- If using a large milk bottle you may not need to cut both sides out
- Place the pencil into the grooves and see if the wheel has room to spin around without touching the sides, if it doesn't then cut more of the bottle away.

**Step 9:**

- The purpose of a water wheel is not just to spin around, it is designed to be able to move and power other machinery
- To demonstrate this attach a piece of wool to one end of the pencil, you can use Plastacine around the pencil to stop it sliding about
- On the other end of the wool attach a piece of waste plastic
- If you turn the wheel the wool should wind around the pencil and the piece of plastic should lift up off the ground, to lower it turn the wheel the other way

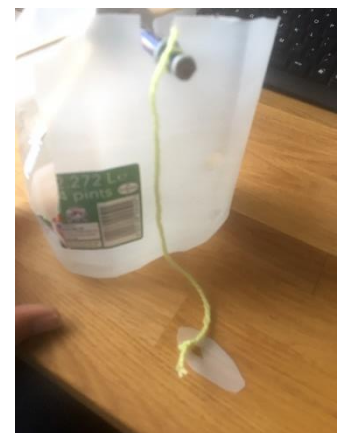

Step 10:

- When you are happy with your waterwheel it is time to test it.
- Lots of the water you pour over the wheel will collect in the milk bottle, but you may want to try it over the sink, bath or outside!
- Use a jug / bottle or water/ watering can to gently but steadily pour water onto one of the paddles, you may need to experiment with your pouring technique to get it working!



Ideas for other waterwheel designs:

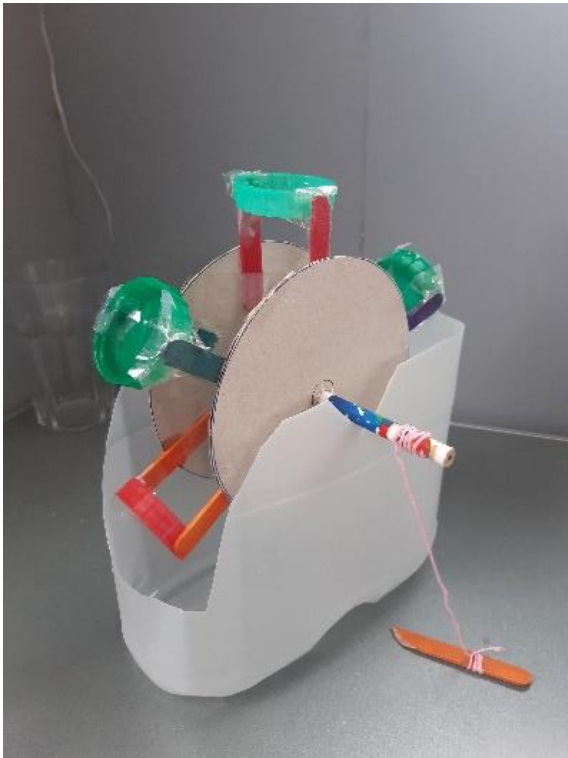

You could also think about making a water channel for your waterwheel, where will the water hit the wheel, will it be a breast shot, overshot, pitchback or undershot design?

See the next diagram for ideas.

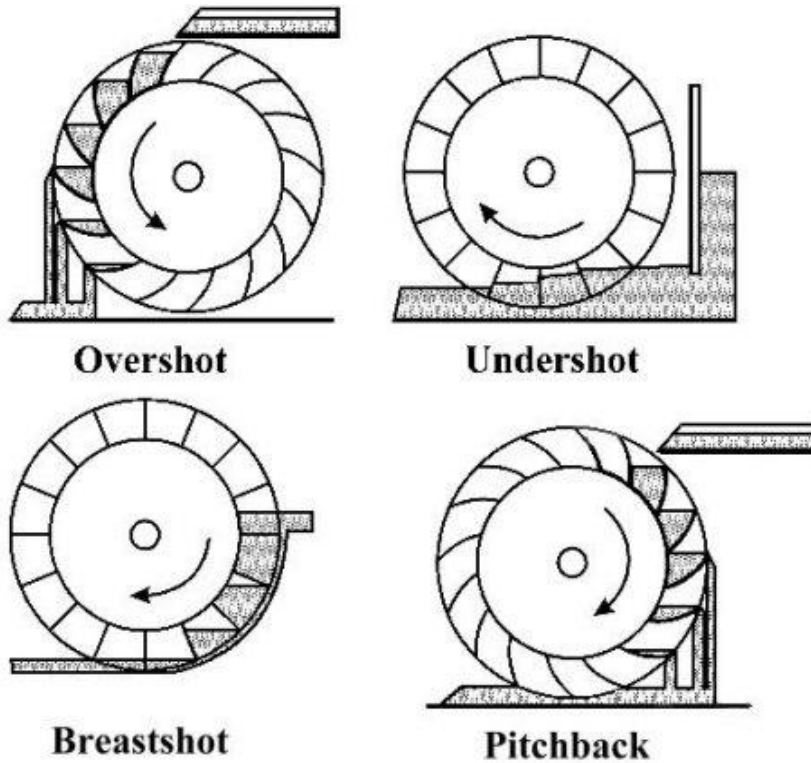

Please let us know what you think of this activity and share your work with us

When you have had a go at this activity, we'd love to hear what you think, or see your work. Please send us any feedback below by 12th October 2020.

Post us your work – If you would like to post us any of your work or let us know what you think of this activity with a note with your name and address (and age if you'd like to share that). We are hoping to have an exhibition in the Autumn on one of the mill sites of the work created by people all along the valley. We will return all your work to you after the exhibition.

Postal address:

Georgina Greaves (DVMWHS Creativity Packs)
Derbyshire County Council
North Block S7 - County Hall
Matlock
Derbyshire DE4 3AG

Send us a photo – Email a photo of your creation to info@derwentvalleymills.org

Social Media – If you use social media use #DVMWHSCreativity and post the images of your work and tag us at:



Facebook: @DerwentValleyMillsWHS



Twitter: @DVMillsWHS



Instagram: @DerwentValleyMillsWHS

Hope you enjoy doing this craft activity!